

MODULUS SYSTEM

SAFE

SMART

SECURE

FLEXIBLE



NEMTEK
Electric Fencing Products



www.nemtek.com

COMPONENT LIST

Modulus End Cap 19 x 19
EMOD - BENDCAP

Modulus Slide Insulator
EMOD - BSLD

Grub Screw 304 SS 4x12

Modulus End Cap Tripple 26 x 19
EMOD - BENDCAP 3

Machine 304 SS 4x12 Counter Sunk

Modulus Mounting Bracket.
Single hole
EMOD - BRKT

Modulus Spacer
EMOD - BSPR

Modulus 2-WAY Brackets.

| | |
|----------------|--------------|
| 2360mm/24 wire | EMOD - 2360C |
| 1960mm/20 wire | EMOD - 1960C |
| 1160mm/12 wire | EMOD - 1160C |
| 960mm/10 wire | EMOD - 960C |
| 460mm/5 wire | EMOD - 460C |

Modulus 3-WAY Brackets.

| | |
|----------------|-----------------|
| 2360mm/24 wire | EMOD - 3WS2360C |
| 1960mm/20 wire | EMOD - 3WS1960C |
| 1160mm/12 wire | EMOD - 3WS1160C |
| 960mm/10 wire | EMOD - 3WS960C |
| 460mm/5 wire | EMOD - 3WS460C |

Modulus Hook
ES-HK/MOD

Allen Key's
Number 3 & 6

The Patented Modulus brackets, are designed with Flexibility in mind. By using the different components a full range of sizes and different applications can be formulated.

The key components are the 2-way and 3-way brackets. The 2-way is primarily used as an intermediate bracket. The 3-way is used as an end tensioning post, as a corner post, to change the wire direction, or as an inline strain post on long straight walls.

NEMTEK
Electric Fencing Products



The 2-way is primarily used as an intermediate bracket. A typical spacing (pitch) between wires is 100mm, but by using the Modulus spacers, different spaces (itches) can be achieved.

2-WAY: TYPICAL ASSEMBLY

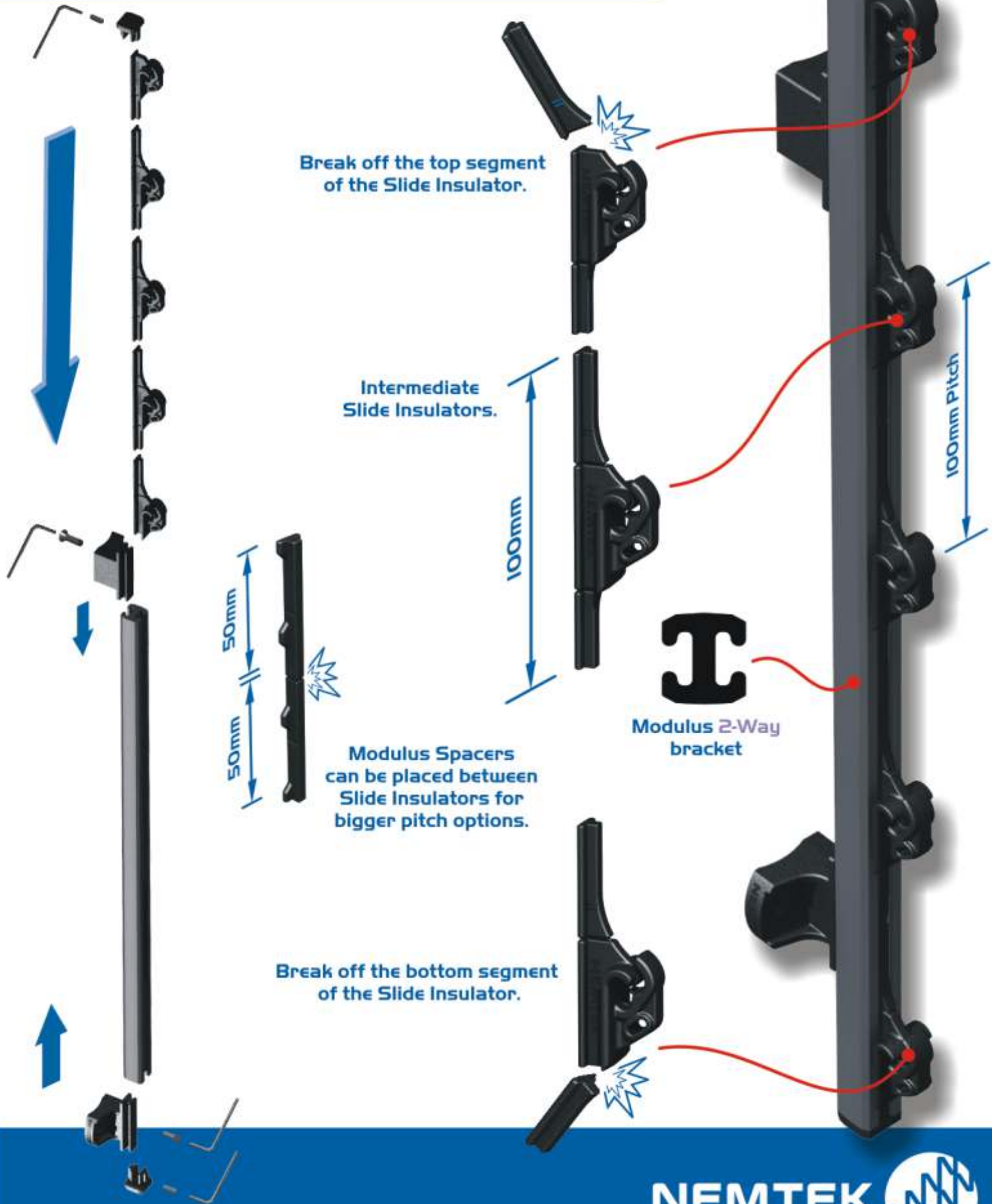

The 3-way bracket is heavier and stronger, it can be used as a tensioning bracket (page 4), as a corner post (page 4), or as an inline strain post (page 9).

3-WAY: TYPICAL ASSEMBLY

Standard NEMTEK Spring Tensioner.

Wire

Modulus 3-Way bracket



3-WAY: CORNER SYSTEM

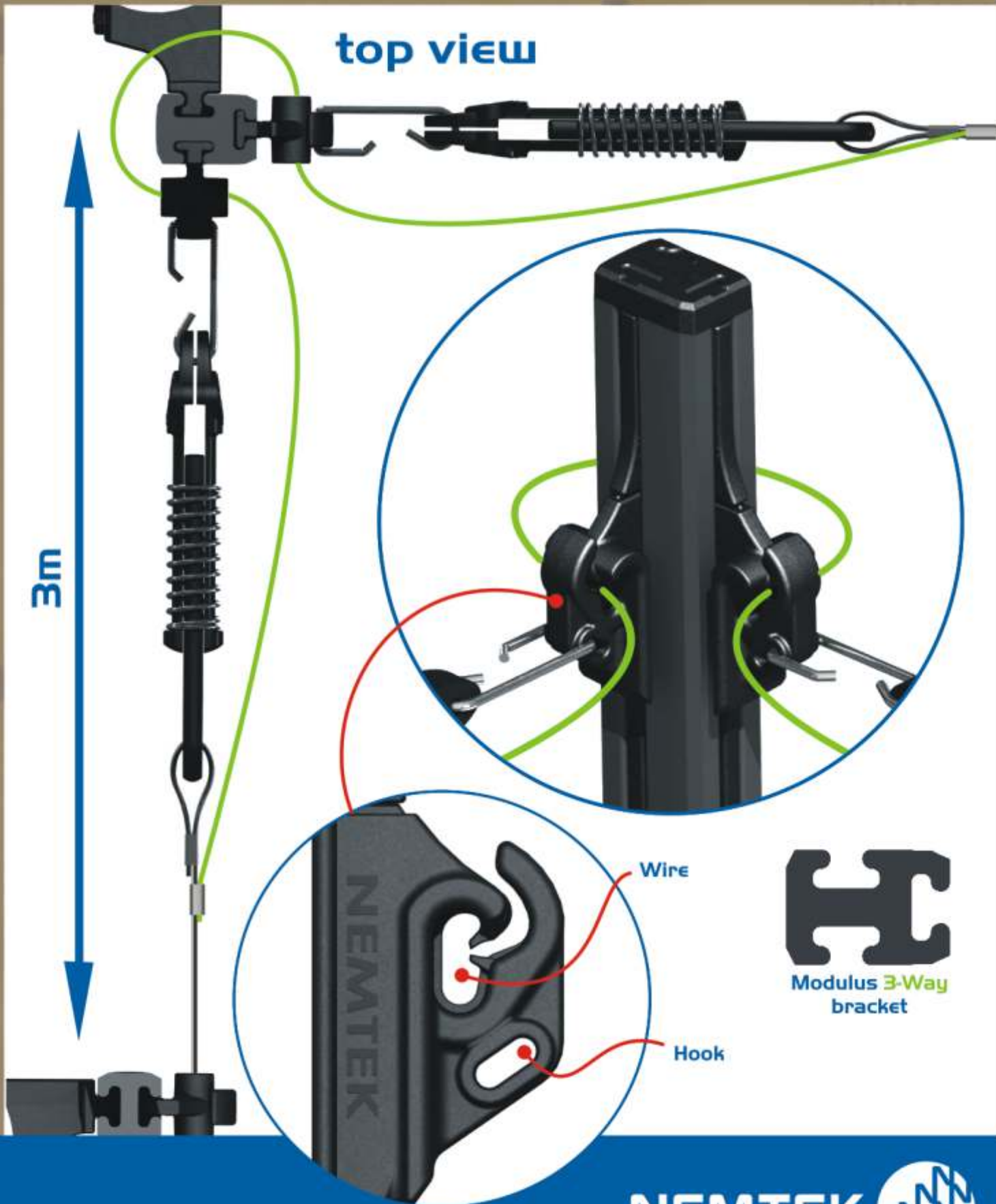

3-WAY: END OR CORNER SYSTEM

side view

The Stay and Lug are used to further strengthen the end/corner post, which is under tension.

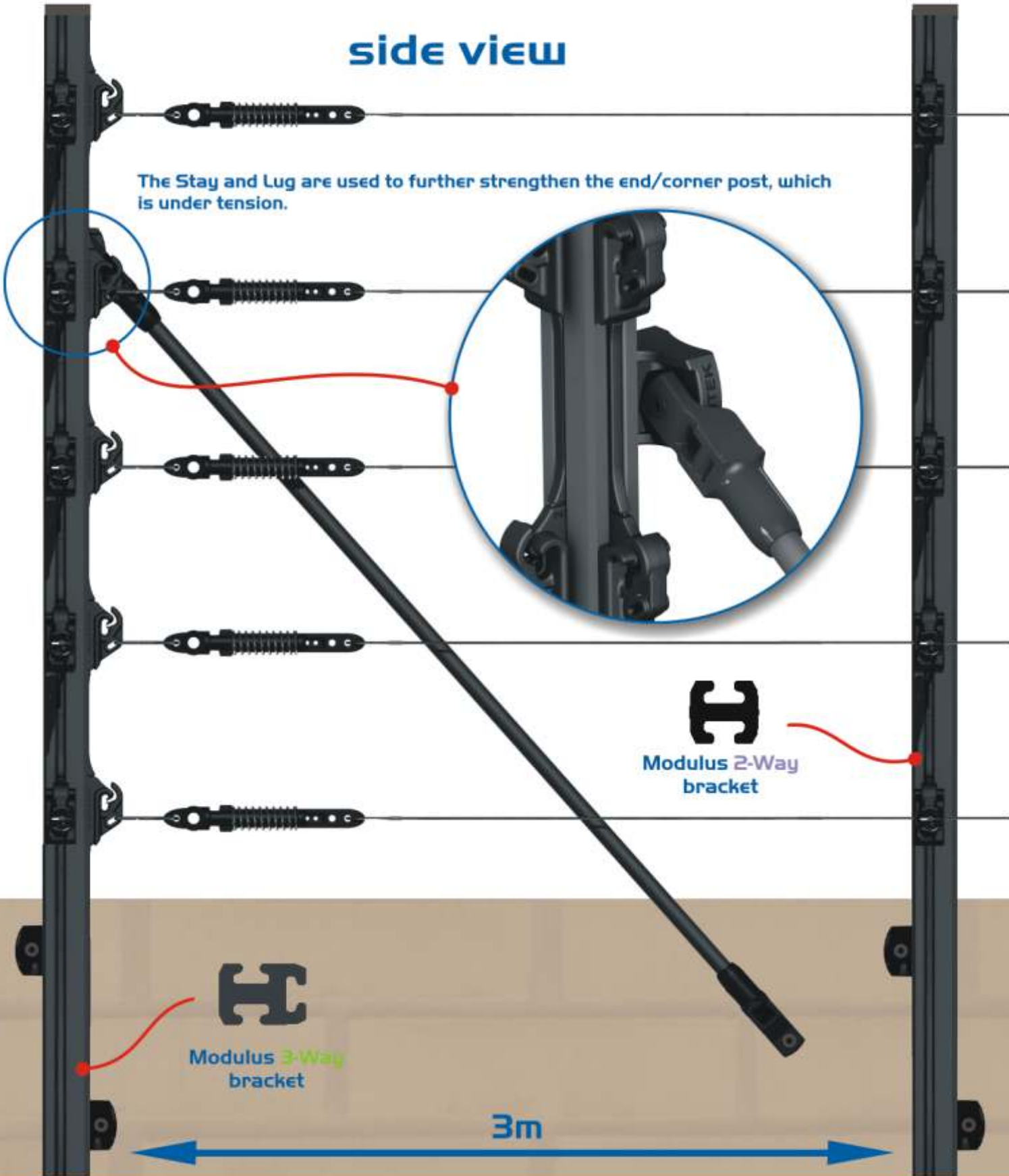



Modulus 2-Way
bracket

Modulus 3-Way
bracket

3m

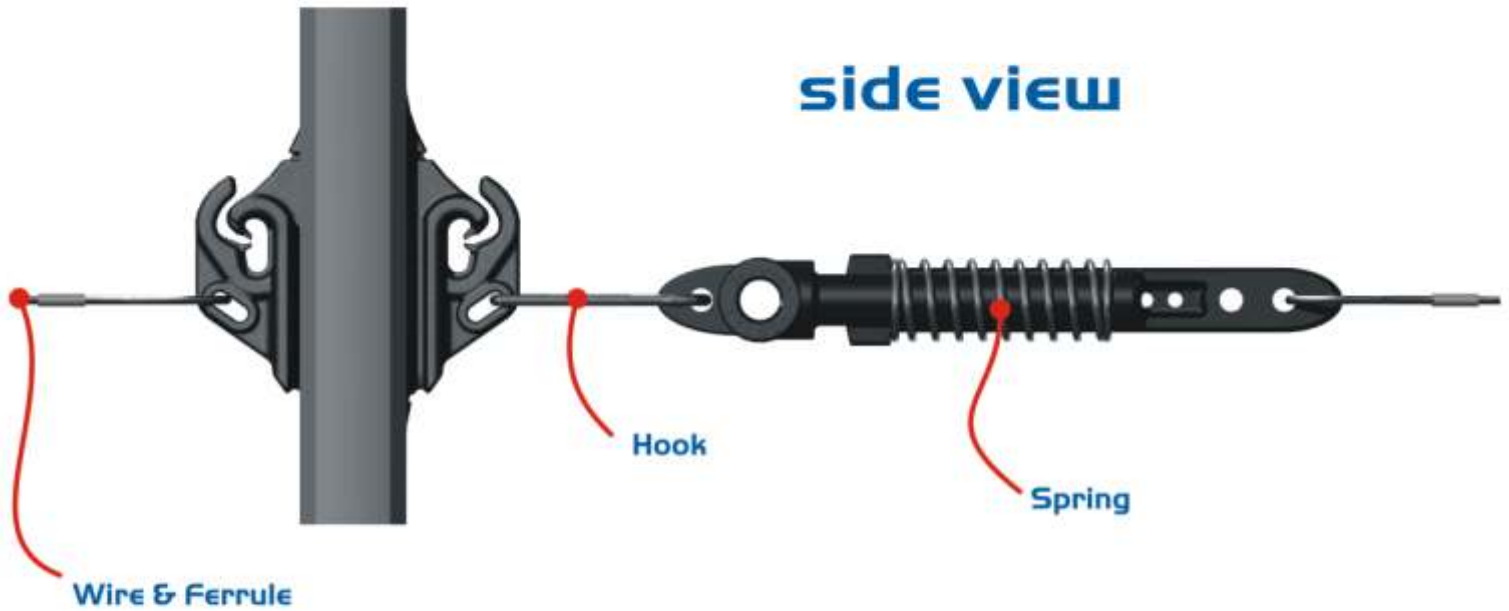
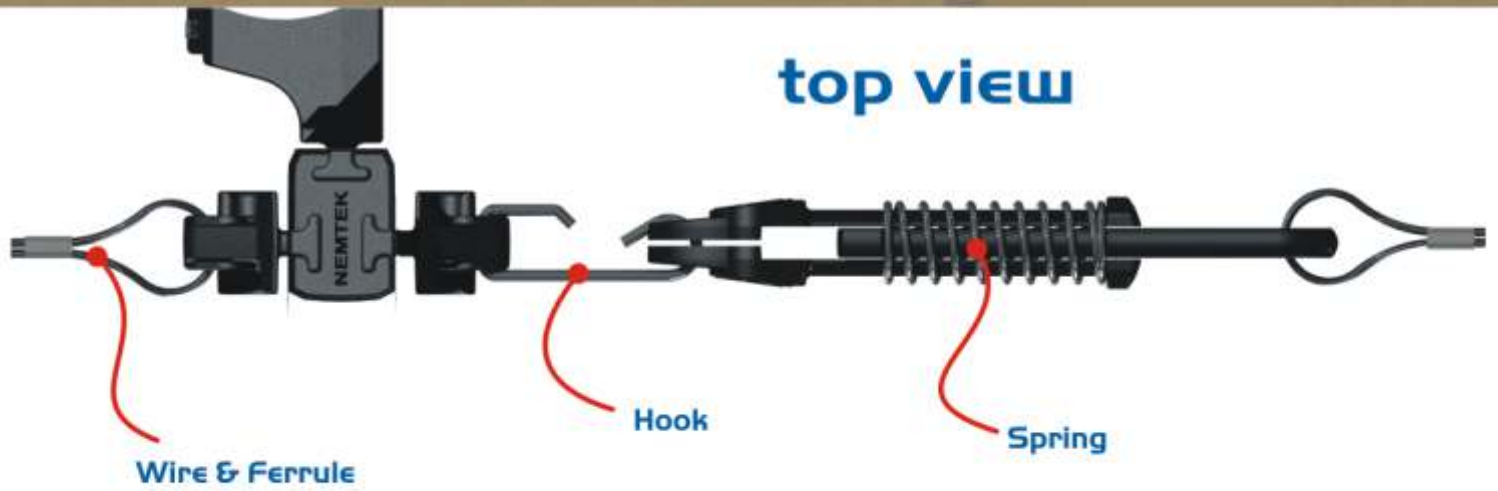

3-WAY: ZONE SPLITTING SYSTEM



DOUBLE ZONE SYSTEM

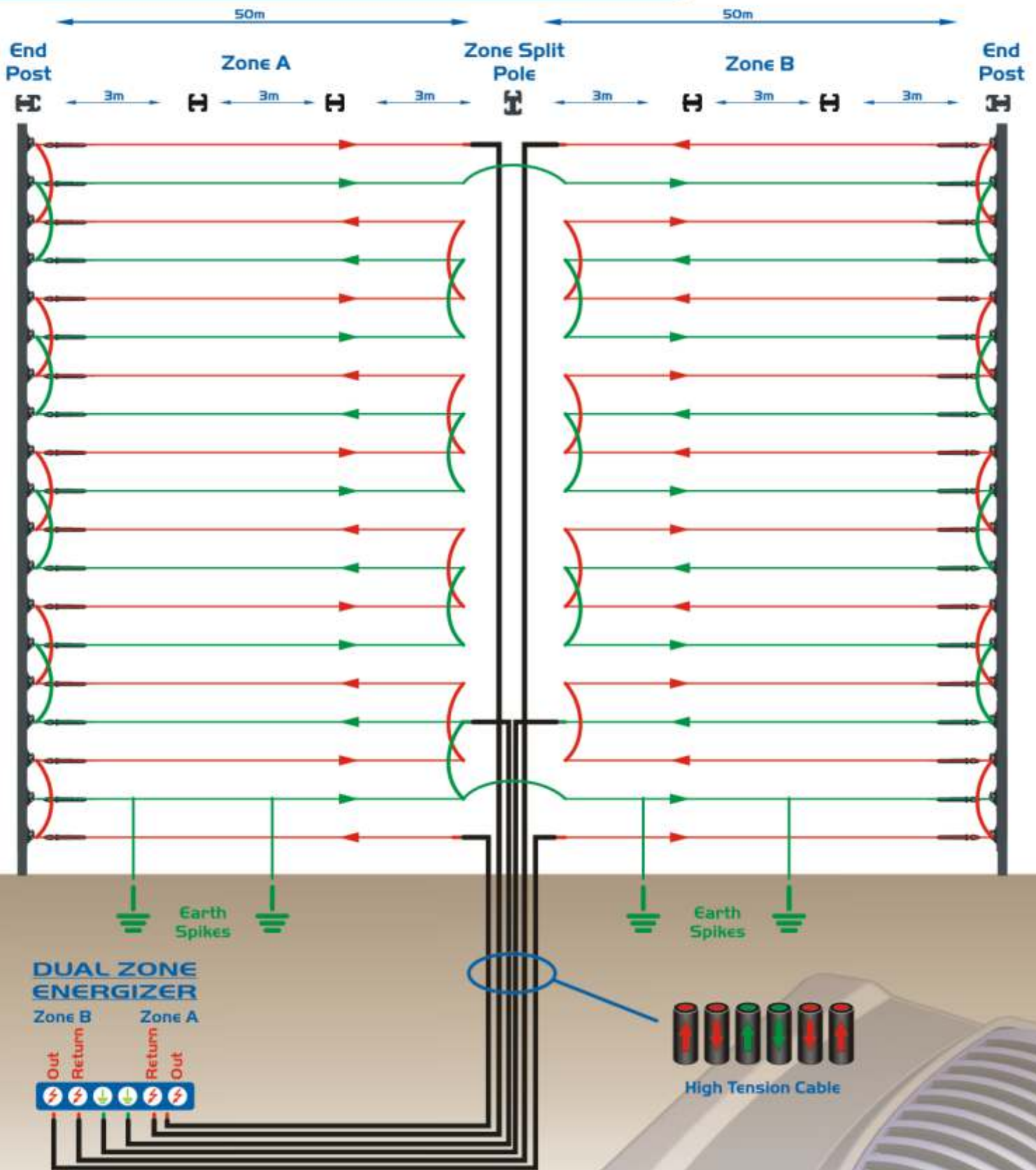

A typical Dual zone system using a 3-Way bracket to split and tension the zones. The diagram shows how the earth wires would be wired to monitor their status against being cut.

The bottom earth wire is used as the earth spike sacrificial wire. The end post can be changed to a zone split post, so as to increase additional zones.

NEMTEK
Electric Fencing Products



GATE CONTACT & ASSEMBLY

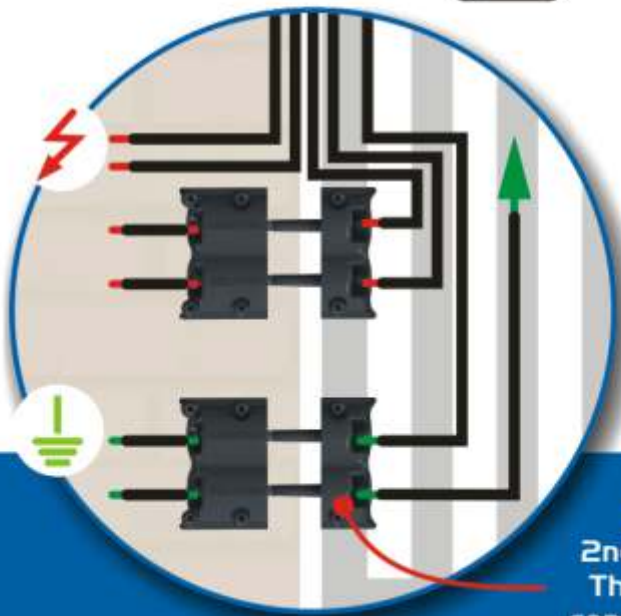
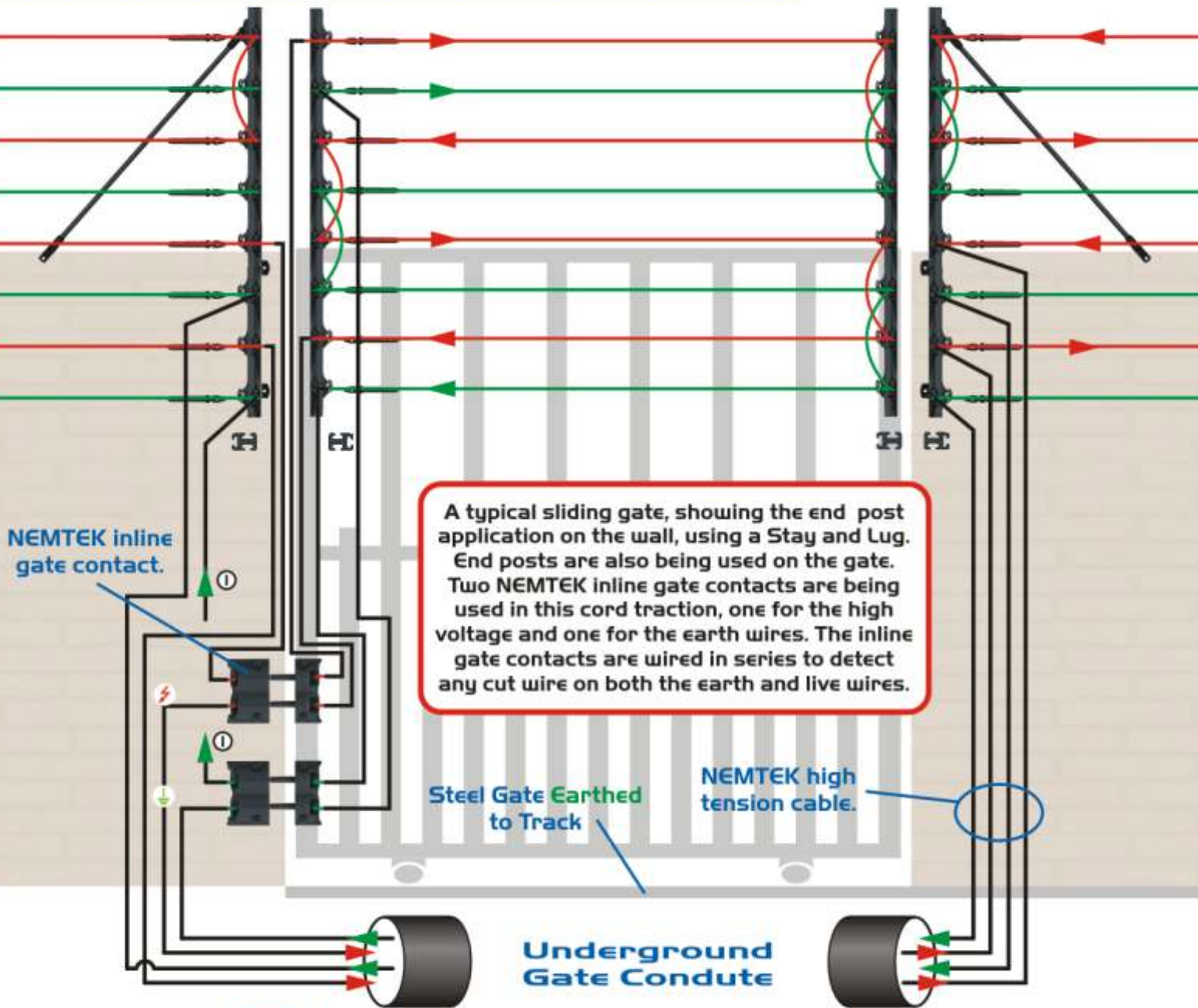

HIGH SECURITY ASSEMBLY OPTIONS

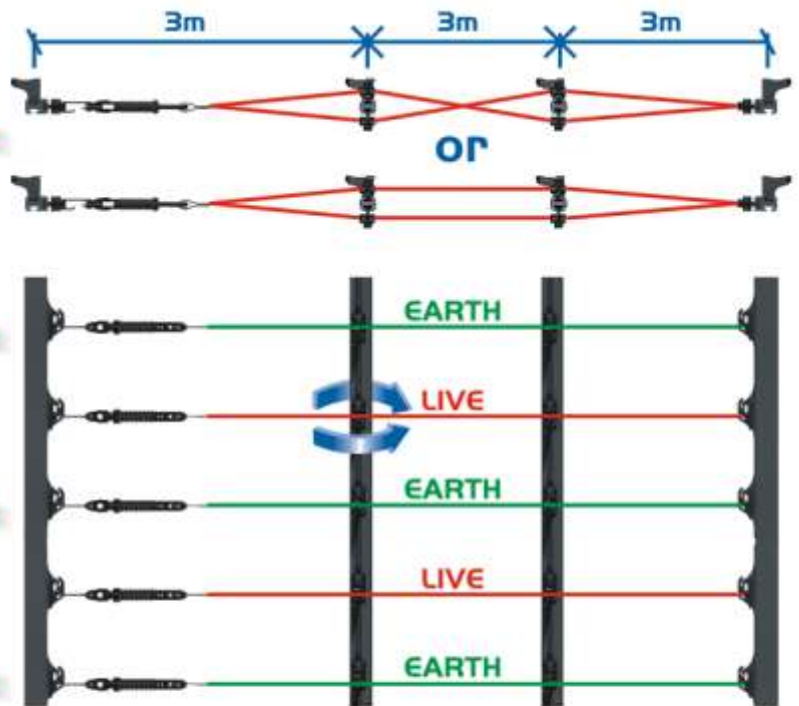
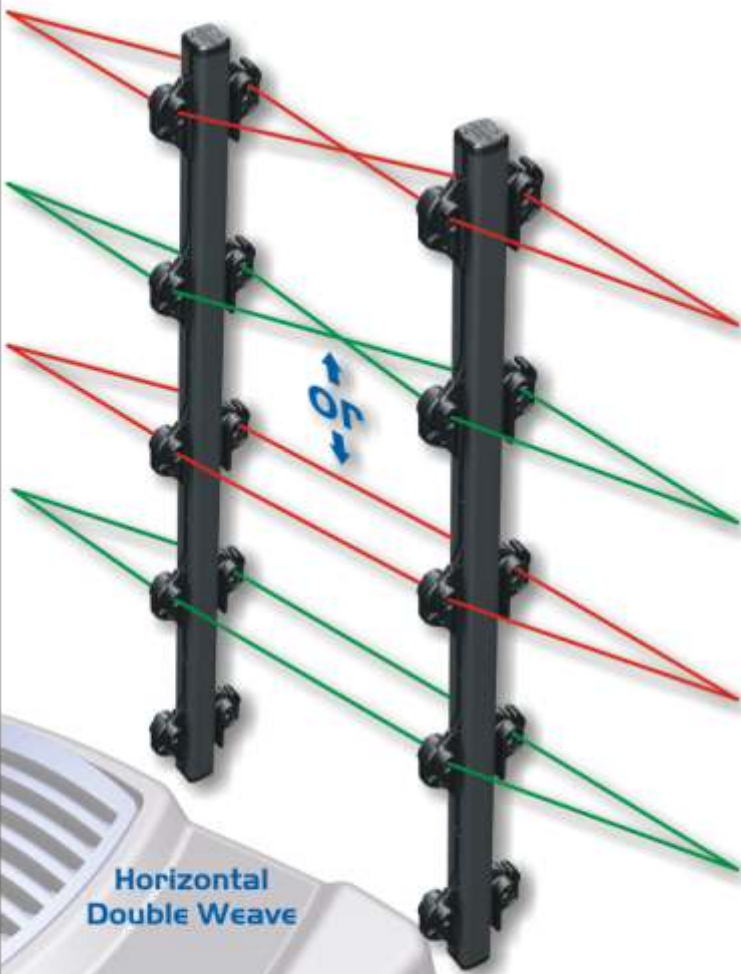
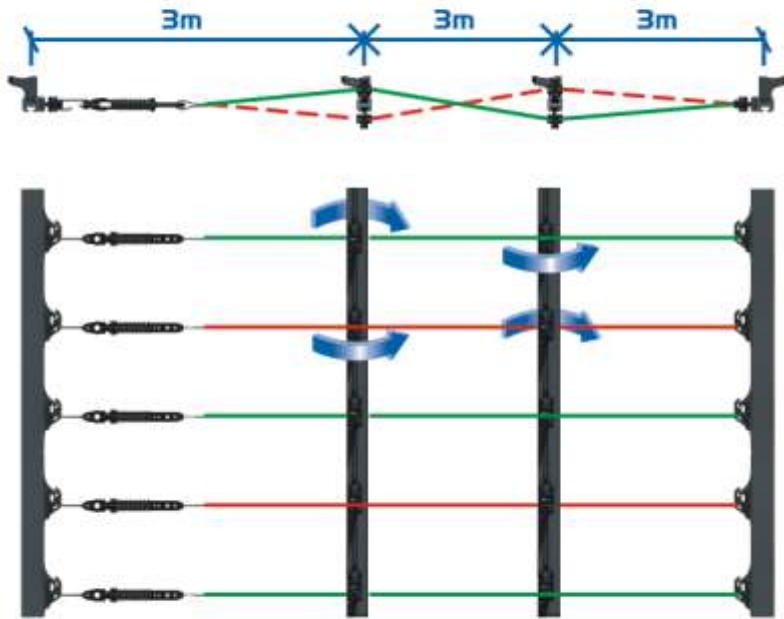

HIGH SECURITY ASSEMBLY

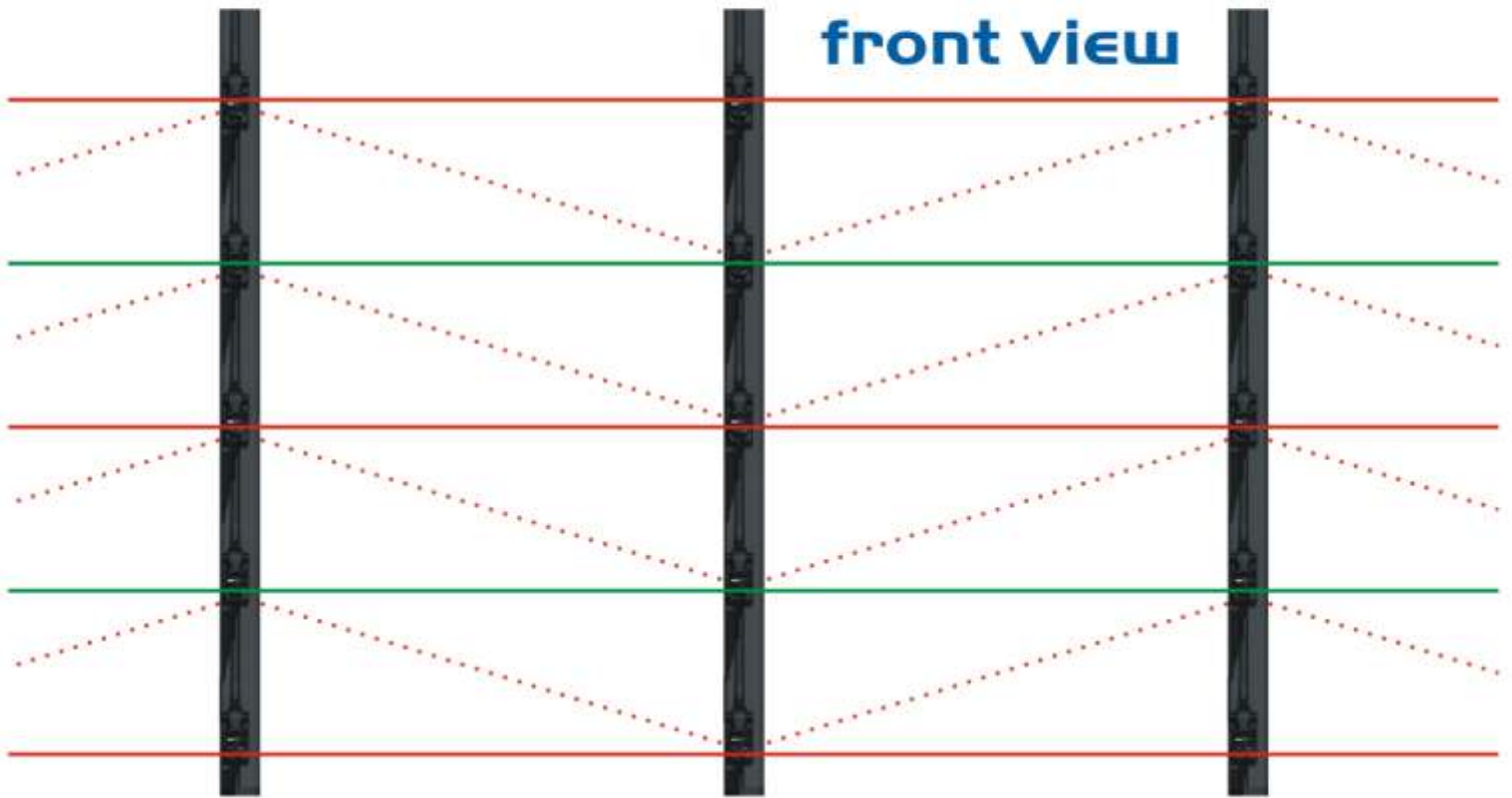

- Front of bracket (earth)
- Front of bracket (live)
- ⋯ Live wires weaving at the back of the bracket. This reduces the likelihood of parting the front wires.

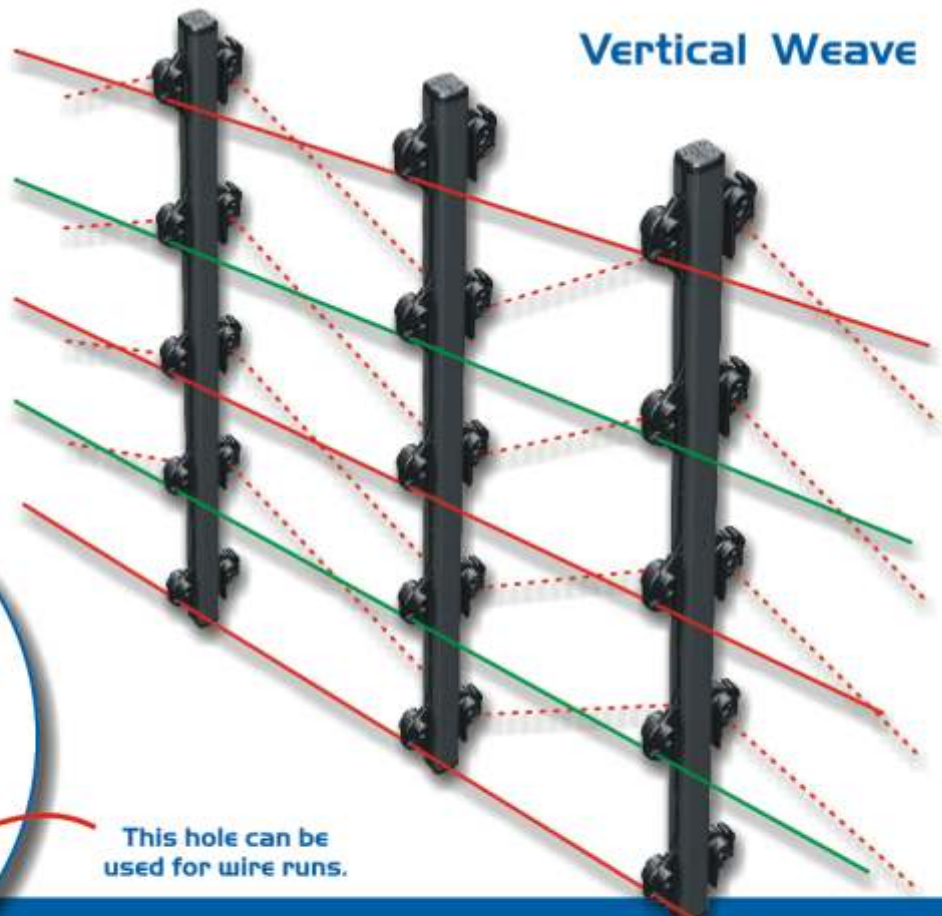

This hole can be used for wire runs.



TYPICAL MODULUS SYSTEM SITE

- Inner Corner
- Zone Splitter, inline strainer
- End Post
- Outer Corner
- Intermediate Posts
- Merlin 2 Zone Energizer (M255)

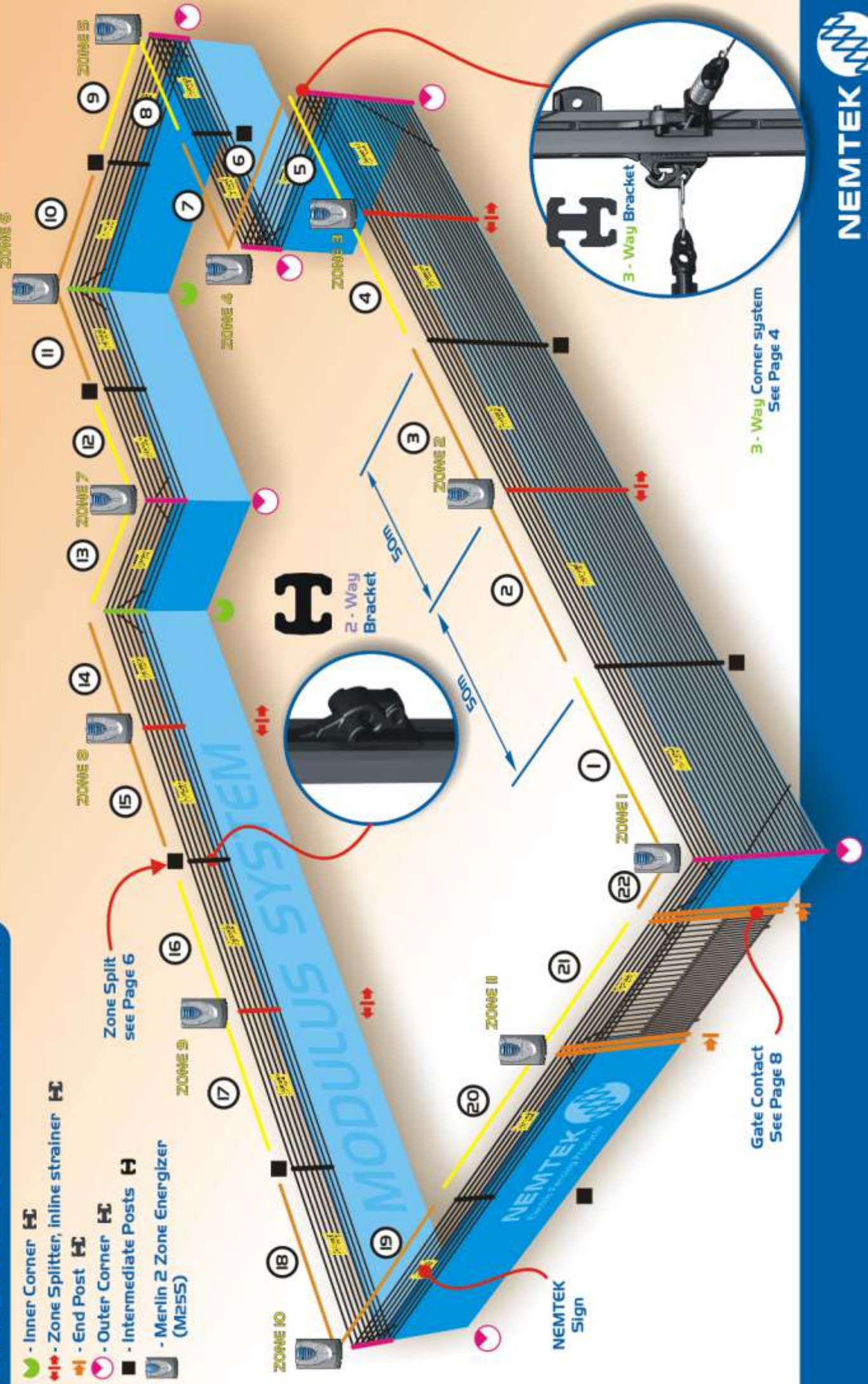

3 - Way Corner system
See Page 4

Gate Contact
See Page 8

